

Article number: 03504080

Description: Fluro Rod end GE 80LO

Measures

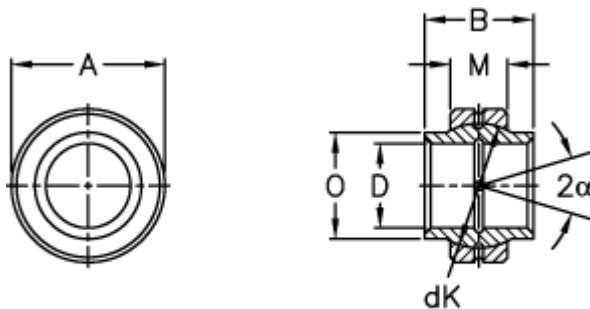

Str. 12 den smørerille

A	= 120 0 -0,015	Tilt angle = 4
B	= 80	Weight = 2600
D	= 80 0 +0,030	
dK	= 105	
Dynamic load C (kN)	= 400	
M	= 45	
O	= 91	
Static load C0 (kN)	= 2000	